

KNX-DALI Controller

Instruction Manual



MDL64-KT.53

Before using this product, please read this manual carefully and keep it properly!

Document Version: C

◆◆ Overview

KNX-DALI Controller (Model No.: MDL64-KT.53, hereinafter referred to as “the product” or “the device”) is a DALI-2 dimming control module based on KNX communication protocol. The device has single-loop control, zone/group control, scene control, and can realize intelligent control of lighting equipment and linkage control of intelligent equipment through APP.

Note: Please note that the pictures and illustrations provided in this instruction manual are for reference purposes only, and the actual product may differ.

Main Functions:

- Supports 64 DALI drivers with different functions;
- Switching, dimming, color temperature and color (RGB, RGBW, xy color coordinates) control;
- Control objectives: broadcast, loop, group and scene;
- Address management and assignment of DALI drivers with “HDL KNX Assistant Software”;
- DALI driver scene control, DALI driver scenes can be configured and managed with the “HDL KNX Assistant Software”;
- Status feedback;
- Online upgrade

◆◆ Appearance

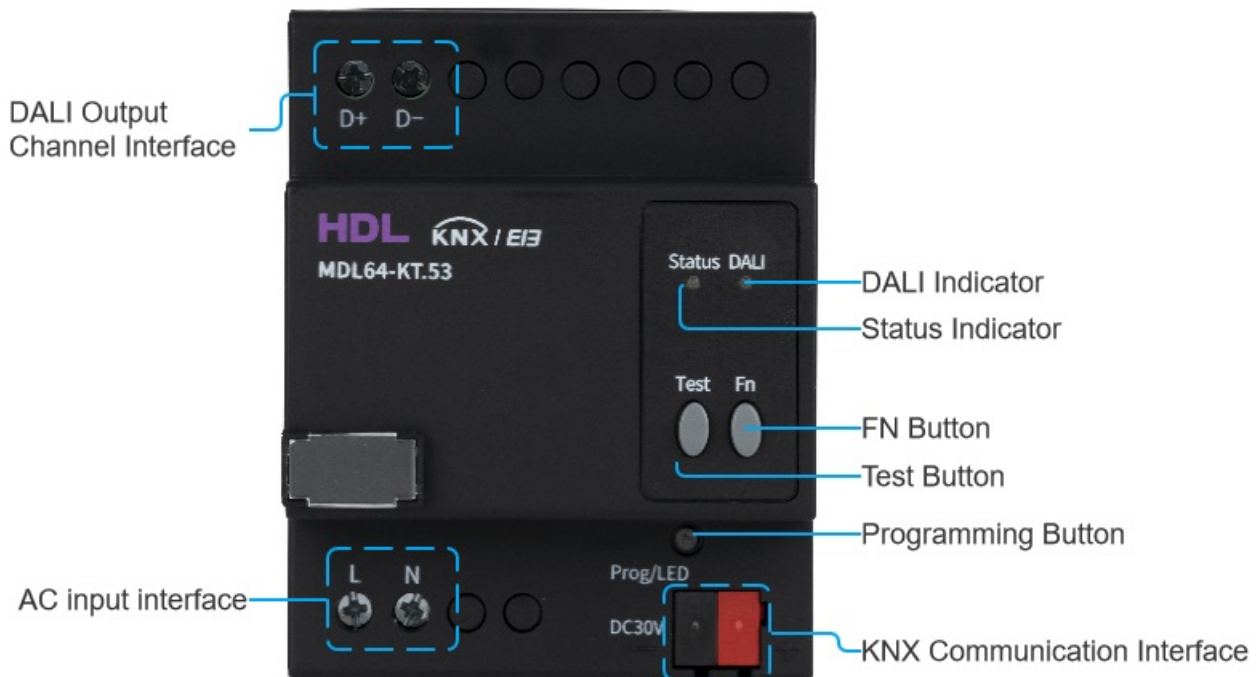

Figure 1

◆◆ Technical Data

Item	Parameter
------	-----------

Rated voltage	21~30V DC
Rated current	5mA/30V DC
Input voltage	100 - 240V AC, 50/60Hz 0.1A
Number of drivers supported	64
Output current	0.25A/17.0V DC
Communication protocol	KNX, DALI
Working temperature	-5°C~45°C
Working relative humidity	≤90%RH, non-condensed
Storage temperature	-20°C~60°C
Storage relative humidity	≤93%RH

◆◆ Specifications

Dimensions (W X H X D)	72×90×64mm (see Figure 2 & 3)
Net weight	241g
Housing material	Nylon
Installation	35mm DIN rail mounting (see Figures 5 & 6)
IP degree (compliant with EN 60529)	IP20
Product Certifications	RoHS, CE

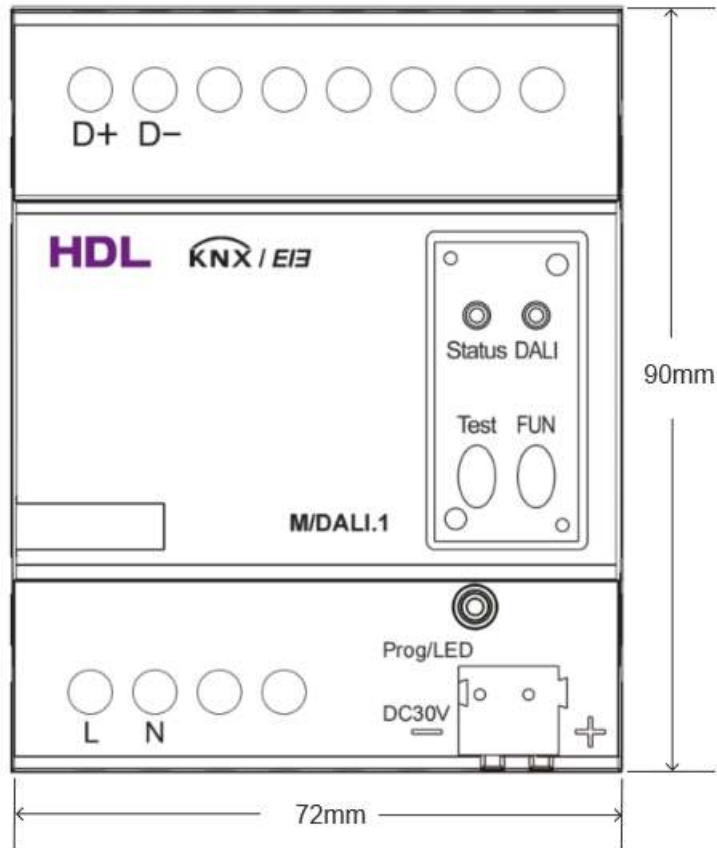

Figure 2

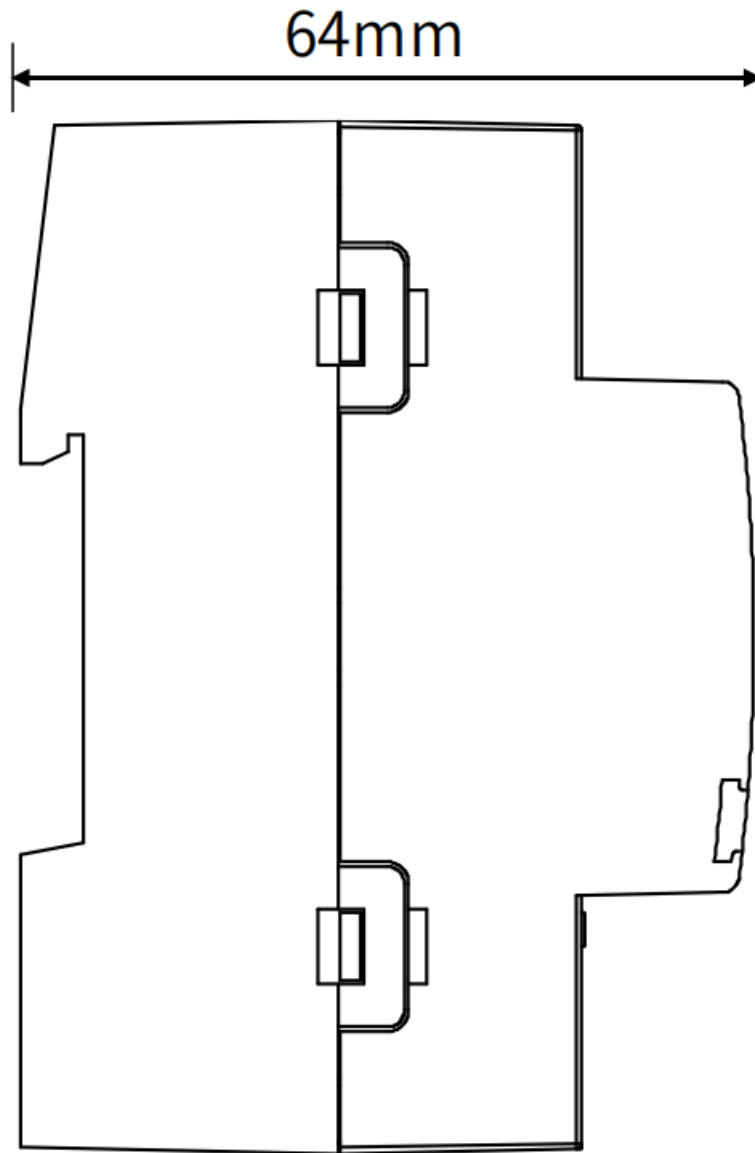

Figure 3

◆◆ Safety Precaution

Danger:

Please do not privately disassemble or replace any parts of the product. Otherwise, it may cause mechanical fault, electric shock, fire or personal injuries.

Warning:

- The installation and testing for the product must be carried out by HDL Automation Co., Ltd. (hereinafter referred to as HDL) or its appointed service agencies. The electric construction shall comply with local laws and safety regulations.
- The device should be installed with DIN rail in a distribution box. HDL will not be responsible for any consequence caused by the inexpert or faulty installation and wiring methods, which are not in accordance with the instructions contained in this datasheet.
- Please contact HDL after-sales departments or our designated service agencies for your maintenance service. Product failures caused by private disassembly are not subject to the warranty.

Caution:

- Before performing any installation or disassembly procedures on the device, it is crucial to disconnect the device from all

voltage sources. This step is necessary to ensure the safety of the technician and prevent any potential damage to the device.

- Do not use corrosive liquid to wipe the device body, especially the interface, so to avoid damage to the device.
- Before performing any maintenance or cleaning procedures on the device, it is imperative to disconnect the device from all voltage sources. This precautionary measure is necessary in order to prevent electric leakage and the risk of electric shock.
- Buspro cable: CAT5E or KNX cable.
- For Buspro connection, a hand-in-hand connection is recommended.
- Do not connect the live wire and the neutral wire to the DALI Buspro by mistake.
- There are no polar requirements for DALI Buspro.
- After all of the cables are terminated, check for correct and good terminations.

◆◆ Wiring

Note:

- For Buspro connection, a hand-in-hand connection is recommended.
- Do not connect the live wire and the neutral wire to the DALI Buspro by mistake.
- There are no polar requirements for DALI Buspro.
- After all of the cables are terminated, check for correct and good terminations.

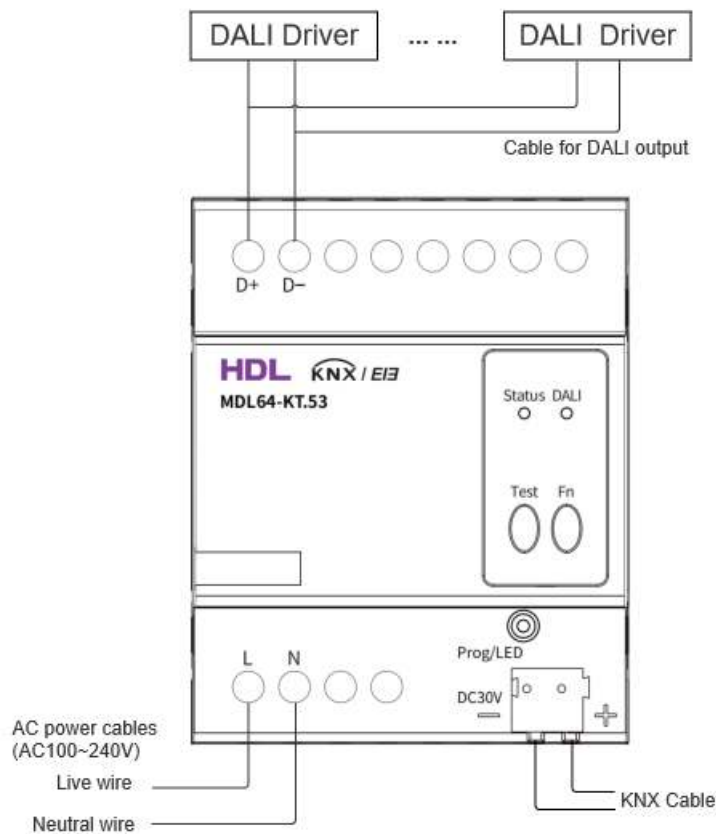

Figure 4

KNX	KNX Cable
-	Black
+	Red

◆◆ Installation

Warning: Before performing any installation procedures on the device, it is crucial to disconnect the device from all voltage sources.

Step 1. Fix the DIN rail with screws.

Step 2. Mount the device on the DIN rail.

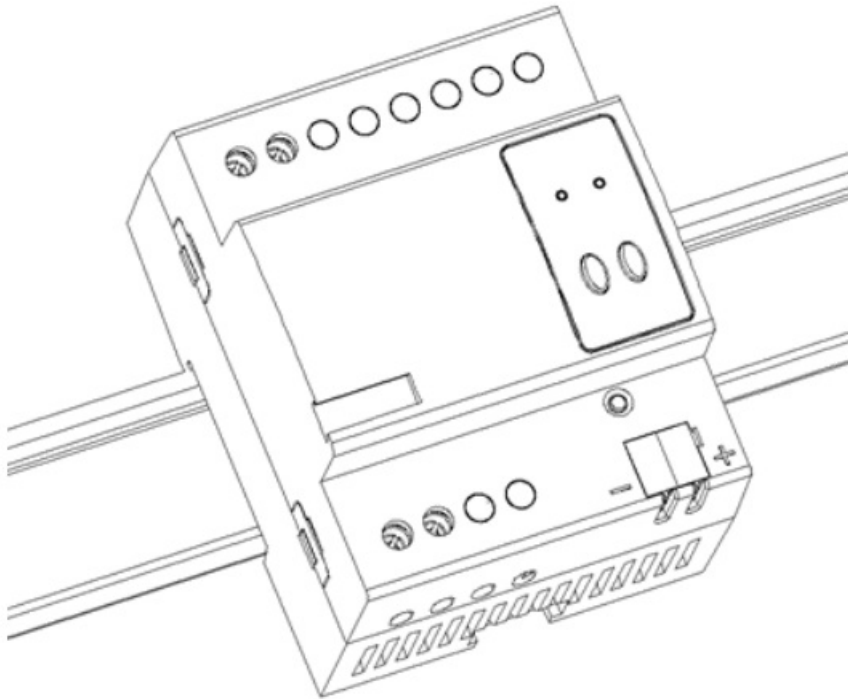

Figure 5

Step 3. Slide the device to the desired position.

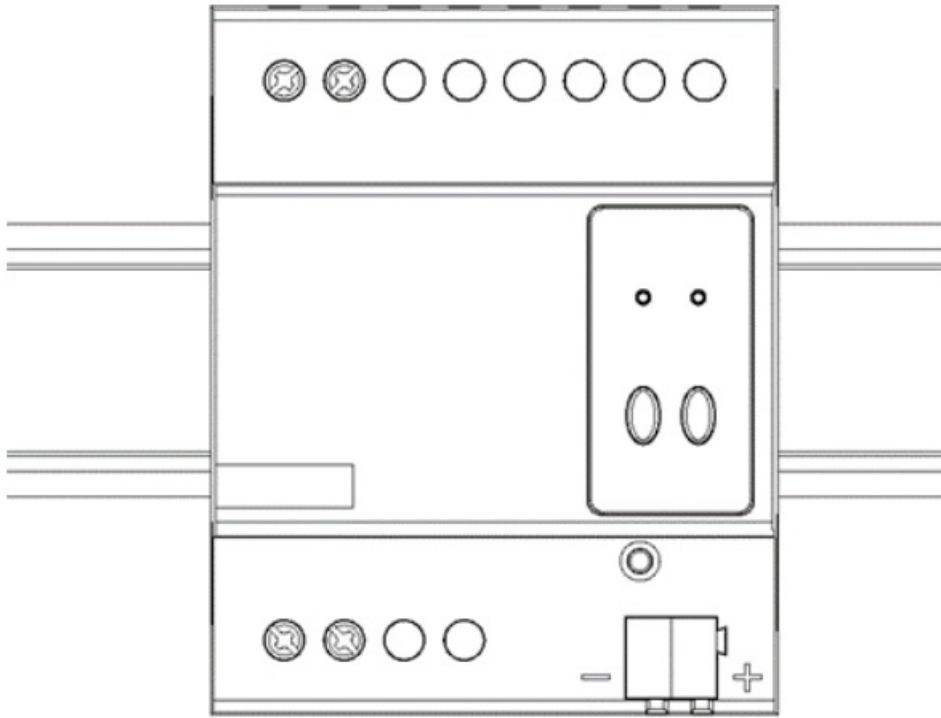

Figure 6

Note: After all of the cables are terminated, check for correct and good terminations. Before powering on, please ensure the device is tightly on the wall.

◆◆ Disassembly

WARNING: Before disassembling, please cut off the power supply, and operation with electricity is strictly prohibited.

◆◆ Operation

The device has the following buttons and indicators.

Tips: To press the buttons, it is recommended to use the appropriate tools, such as an eject pin.

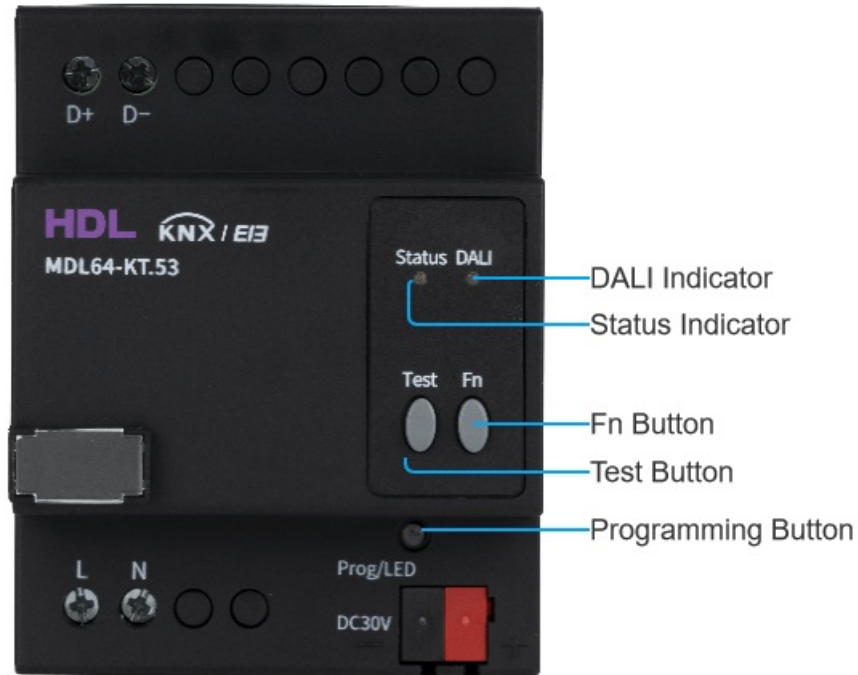

Figure 7

- Programming button / indicator

Operation	Result / Device Status
Long press programming button for 2s	The device enters programming mode, with the indicator turning red.

- Fn button / Status indicator

Operation	Result / Device Status
Short press Fn button	Broadcast control switch, Status indicator red on, all lights on DALI Buspro are on.
Short press Fn button again	Broadcast control switch, Status indicator red off, all lights on the DALI Buspro are off.

- DALI indicator

Operation	Result / Device Status
/	When the device runs normally, the indicator turns green.
/	When DALI Buspro communication is in progress, the indicator flashes red.

Press the Test and Fn buttons at the same time for 15 seconds to recover the faulty drive being recorded. During the recovery process, the red status light and the green status light flash alternately, with a flashing interval of 1 second.

If there is no drive to be recovered, the red and green LEDs light up simultaneously for 3 seconds and then go out.

◆◆ Packing List

- KNX-DALI Controller*1
- Cable Terminal*1
- Label*5
- Instruction Manual QR Code Card*1

◆◆ Warranty

Warranty period (five years from the date of invoice), if the product fails in normal use, the user can go to the nearest authorized institution with a valid warranty card to obtain free maintenance.

In the following cases, HDL regards the user as giving up the relevant services promised under the warranty and the user shall bear the corresponding responsibility and shall not be entitled to the free warranty:

- Failure of the device caused by force majeure factors.
- The user has placed the device in a transportation or use environment that does not comply with the statements in the product instructions or technical manuals.
- Unauthorized disassembly of the product by the user.
- Promises not made officially by HDL to the user that are beyond the scope of the warranty are the responsibility of the promisor.

HDL reserves the right to update or change the product without prior notice to the user, please visit the HDL website for answers to your questions and the latest product information.

The final interpretation right of the warranty regulations belongs to HDL.

◆◆ Copyright Statement

HDL has all the intellectual property rights to this document and contents thereof. Reproduction or distribution for third parties are prohibited without written authorization from HDL. Any infringement of HDL's intellectual property rights will be investigated the legal liability.

The contents of this document will be updated as the updates of product versions or other reasons. Unless otherwise agreed upon, this document is to be used as a guidance only. All the statements, information and recommendations in this document makes no warranty expressed or implied.

© 2024 HDL Automation Co., Ltd. All rights reserved.

Update History

The form below contains the information of every update. The latest version contains all the updates of all former versions.

Version	Update Information	Date
V1.0	Initial release	September 12, 2024

◆◆ Troubleshooting

E-mail: hdltickets@hdlautomation.com

Website: <https://www.hdlautomation.com>

◆◆ Technical Support

E-mail: hdltickets@hdlautomation.com

Website: <https://www.hdlautomation.com>